

USER'S GUIDE

Calibration of Series HMD/W60/70 and
HMP140 Transmitters with
Vaisala HUMICAP® Indicator HMI41

PUBLISHED BY

Vaisala Oyj
P.O. Box 26
FIN-00421 Helsinki
Finland

Phone (int.): +358 9 8949 1
Fax: +358 9 8949 2227

Visit our Internet pages at <http://www.vaisala.com/>

© Vaisala 2006

No part of this manual may be reproduced in any form or by any means, electronic or mechanical (including photocopying), nor may its contents be communicated to a third party without prior written permission of the copyright holder.

The contents are subject to change without prior notice.

Please observe that this manual does not create any legally binding obligations for Vaisala towards the customer or end user. All legally binding commitments and agreements are included exclusively in the applicable supply contract or Conditions of Sale.

Contents

1. INTRODUCTION	1
1.1 HMI41 with calibration option	1
1.2 Selecting the HMI41 calibrator function	1
2. OUTPUT SCALE SELECTIONS.....	3
2.1 Standard transmitter settings.....	3
2.2 Getting started	3
2.3 Scale selection modes.....	4
2.3.1 Voltage output selection mode (U)	4
2.3.2 Current output selection mode (I).....	5
2.3.3 Customized voltage output selection mode (cU)	6
2.3.3.1 Humidity channel	7
2.3.3.2 Temperature channel.....	9
2.3.4 Customized current output selection mode (cI)	10
2.3.4.1 Humidity channel	11
2.3.4.2 Temperature channel.....	12
3. CALIBRATION	13
3.1 Getting started	13
3.2 Humidity calibration.....	15
3.3 Temperature calibration	16

APPENDIX 1: QUICK REFERENCE TO SCALE SELECTIONS AND CALIBRATION

This page intentionally left blank.

1. INTRODUCTION

1.1 HMI41 with calibration option

The HMI41 can be used as a field calibrator for various Vaisala humidity transmitters. There are three different calibration cables available:

- **19116ZZ** for the calibration of **HMD/W60/70 and HMP140 series analogue transmitters**
- 19164ZZ for the calibration of HMP230 series digital transmitters
- 19165ZZ for the calibration of the HMD/W20/30 and HMP130 series analogue transmitters

In this manual, only the calibration of the HMD/W60/70 and HMP140 series analogue transmitters is dealt with. For other calibration options, please refer to corresponding manuals.

Calibration is quick and easy to perform. Yet, the HMI41 includes four output scale selection modes which cover all scalable features of analogue transmitters and provide for a simple and reliable on-site calibration of even customized transmitters. In calibration, the HMI41 measures relative humidity and temperature with a separate probe, and receives the RH and T information from the transmitter. These values are then compared on the HMI41 display and the transmitter is adjusted with calibration potentiometers inside the transmitter.

1.2 Selecting the HMI41 calibrator function

The desired calibrator function is selected in the HMI41 setup menu. To enter the setup mode, first press the ON/OFF button and the following appears:

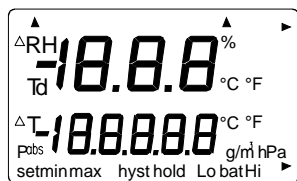

Then release the ON/OFF button and within 1...2 seconds press both ENTER and MODE buttons until the following text appears on the display:



After a few seconds, the text changes automatically to show the following:

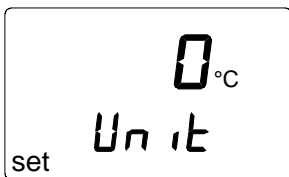

If the basic settings of the HMI41 (display units, automatic power off function, display quantities and pressure) have to be changed, please refer to the HMI41 Operating Manual. Otherwise, press ENTER repeatedly until the following text appears:

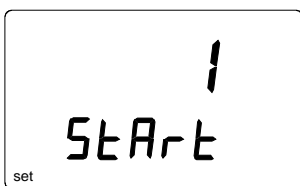

The number on the first line of the display corresponds to the following HMI41 functions:

- 1 = HMI41 as a humidity and temperature indicator
- 2 = HMI41 as a calibrator for HMD/W60/70 and HMP140 series analogue transmitters**
- 3 = HMI41 as a calibrator for HMP230 series digital transmitters
- 4 = HMI41 as a calibrator for the HMD/W20/30 and HMP130 series analogue transmitters

To calibrate the HMD/W60/70 or the HMP140 series transmitters, select number 2 with buttons ▲ (number up) and ▼ (number down) and then turn the HMI41 off. When the HMI41 is turned on again, it will automatically wake up as a calibrator for these analogue transmitters. If you wish to calibrate transmitters of some other type or use the HMI41 as an indicator, this selection has to be done accordingly; refer to corresponding manuals for further details.

Note that if the default settings in the HMI41 memory have not been changed (e.g. when it is used as a calibrator for the first time), the HMP140 series transmitters with standard settings and voltage outputs can be directly calibrated (see Chapter 3). In all other cases scale selections are necessary; please, consult Chapter 2. The default settings in the HMI41 memory (Table 1.2) are returned with U, I, cU or cI selections according to which changes have been made.

Humidity range	Temperature range	Voltage range
0...100 %RH	-40...+60 °C	0...1V
		0...5V
		0...10V

Table 1.2 Default settings in the HMI41 memory

2. OUTPUT SCALE SELECTIONS

2.1 Standard transmitter settings

In Table 2.1 you will find the standard settings of the HMD/W60, HMD/W70 and the HMP140 series transmitters.

Transmitter	Relative humidity scaling range	Temperature scaling range	Voltage output	Current output
HMP140	0...100 %RH	-40...+60 °C	0...1 V 0...5 V 0...10 V	0...20 mA
HMD60	0...100 %RH	-20...+80 °C		4...20 mA
HMD70	0...100 %RH	-20...+80 °C	0...1 V 0...5 V 0...10 V	0...20 mA
HMW60	0...100 %RH	-5...+55 °C		4...20 mA
HMW70	0...100 %RH	-5...+55 °C	0...1 V 0...5 V 0...10 V	

Table 2.1 Standard settings of analogue transmitters

NOTE

When calibrating transmitters with current outputs, make sure that the output loop is terminated.

2.2 Getting started

After having selected the calibrator function 2 as explained in Chapter 1.2, turn the HMI41 on with the ON/OFF button and wait until the following text appears on the display:



This message remains on the display for about 5 seconds; if no button is pressed, the HMI41 goes on to calibration. To enter the scale selections, press any button (except ON/OFF) within 5 seconds and the following appears:

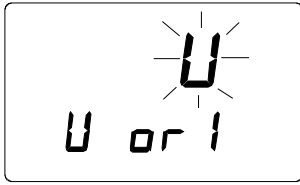

Scale selection mode is entered when this text is on the display.

2.3 Scale selection modes

The HMI41 has four scale selection modes: voltage output (**U**) and current output (**I**) selection modes are used for transmitters with **standard settings**. Customized voltage output (**cU**) and customized current output (**cI**) selection modes are meant for analogue transmitters **with customized RH, T and/or output range settings**. All these selections are stored in the HMI41 memory; therefore, if the transmitter settings or the selections in the HMI41 memory have not been changed by the next calibration, you can calibrate the transmitter directly. In the following, each selection mode is explained in its own section.

2.3.1 Voltage output selection mode (U)

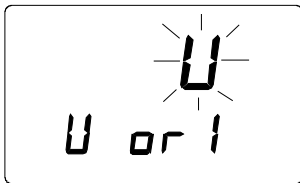

If the transmitter has voltage outputs, its temperature range is given to the HMI41 with the voltage output selection mode (U). The humidity range is always 0...100 %RH. Select the U selection mode with buttons ▲ or ▼ and acknowledge the selection with ENTER. A text similar to the following is displayed:



Numbers on the second line are blinking. They indicate the lower limit of the transmitter's temperature range currently stored in the HMI41 memory. Text in the lower righthand corner is Lo. You can now set the lower limit with buttons ▲ (number up) or ▼ (number down) to correspond to that of the transmitter. Acknowledge the setting with ENTER:

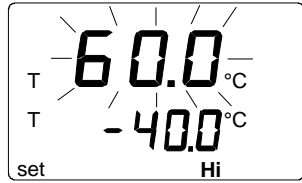

Numbers on the first line start to blink. They indicate the upper limit of the transmitter's temperature range currently stored in the HMI41 memory. Text in the lower righthand corner is Hi. You can now set the upper limit with buttons ▲ (number up) or ▼ (number down) to correspond to that of the transmitter. Acknowledge the setting with ENTER and turn the HMI41 off with the ON/OFF button. You can now calibrate the transmitter (see Chapter 3).

2.3.2 Current output selection mode (I)

NOTE

When calibrating the transmitters with current outputs, make sure that the output loop is terminated.

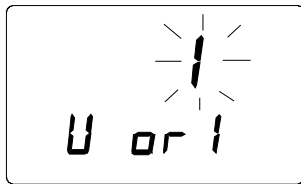

If the transmitter has current outputs, its temperature range is given to the HMI41 with the current output selection mode (I). The RH range is always 0...100 %RH. Select the I selection mode with buttons ▲ or ▼ and acknowledge the selection with ENTER. A text similar to the following is displayed:



Numbers on the display are blinking, and you can now select the output (0...20 or 4...20 mA) with buttons ▲ or ▼ according to the transmitter to be calibrated. Acknowledge the selection with ENTER and a text similar to the following is displayed:

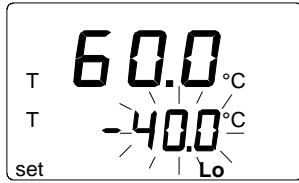

Numbers on the second line are blinking. They indicate the lower limit of the transmitter's temperature range currently stored in the HMI41 memory. Text in the lower righthand corner is Lo. You can now set the lower limit with buttons ▲ (number up) or ▼ (number down) to correspond to that of the transmitter. Acknowledge the setting with ENTER:

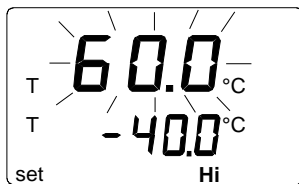

Numbers on the first line start to blink. They indicate the upper limit of the transmitter's temperature range currently stored in the HMI41 memory. Text in the lower righthand corner is Hi. You can now set the upper limit with buttons ▲ (number up) or ▼ (number down) to correspond to that of the transmitter. Acknowledge the setting with ENTER and turn the HMI41 off with the ON/OFF button. You can now calibrate the transmitter (see Chapter 3).

2.3.3 Customized voltage output selection mode (cU)

The customized voltage output selection mode (cU) is selected when the scaling of the RH, T and/or voltage range is not a standard one.

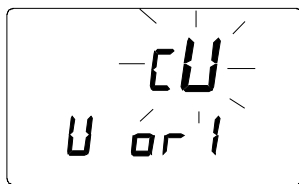

Select the cU selection mode with buttons ▲ or ▼ and acknowledge the selection with ENTER. A text similar to the following is displayed:



2.3.3.1 Humidity channel

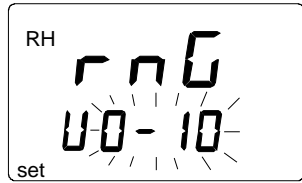

Numbers on the display are blinking. They indicate the voltage range of the transmitter's RH channel (jumper selectable) currently stored in the HMI41 memory. Please, consult Figures 2.3.1 - 2.3.2 when checking the transmitter's jumper positions.

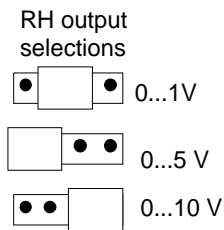

Figure 2.3.1 Jumper selections of the HMD/W70

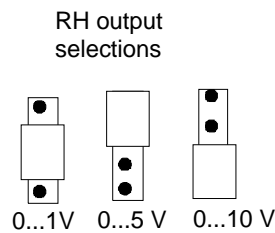
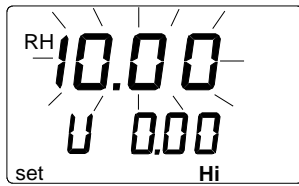

Figure 2.3.2 Jumper selections of the HMP140

Numbers on the second line are blinking, and you can now select the range with buttons ▲ or ▼ according to the transmitter's jumper position. Acknowledge the selection with ENTER. A text similar to the following is displayed:



Numbers on the second line are blinking. They indicate the lower limit of the transmitter's voltage range currently stored in the HMI41 memory. Text in the lower righthand corner is Lo. You can now set the lower limit of the voltage range to correspond to that of the transmitter. Set the limit with buttons ▲ or ▼ and acknowledge the setting with ENTER:



Numbers on the first line start to blink. They indicate the upper limit of the transmitter's voltage range currently stored in the HMI41 memory and the text in the lower righthand corner is Hi. You can now set the upper limit of the voltage range to correspond to that of the transmitter. Set the limit with buttons ▲ or ▼ and acknowledge the setting with ENTER. A text similar to the following is displayed:

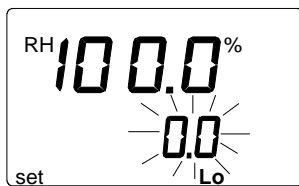

Numbers on the second line are blinking. They indicate the lower limit of the transmitter's RH range currently stored in the HMI41 memory. Text in the lower righthand corner is Lo. You can now set the lower limit of the RH range to correspond to that of the transmitter. Set the limit with buttons ▲ or ▼ and acknowledge the setting with ENTER:

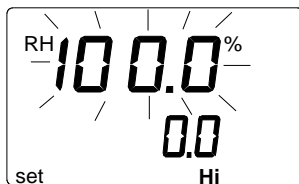

Numbers on the first line start to blink. They indicate the upper limit of the transmitter's RH range currently stored in the HMI41 memory. Text in the lower righthand corner is Hi. You can now set the upper limit of the RH range to correspond to that of the transmitter. Set the limit with buttons ▲ or ▼ and acknowledge the setting with ENTER. The HMI41 goes on to T channel settings, and a text similar to the following is displayed:



2.3.3.2 Temperature channel

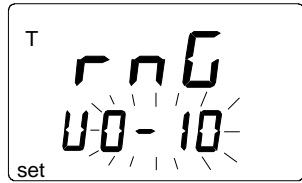

Numbers on the second line are blinking. They indicate the voltage range of the transmitter's T channel (jumper selectable) currently stored in the HMI41 memory. Please, consult Figures 2.3.3 - 2.3.4 when checking the transmitter's jumper positions.

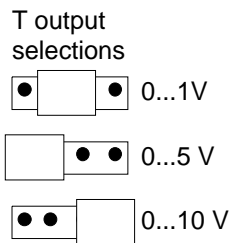

Figure 2.3.3 Jumper selections for the HMD/W70

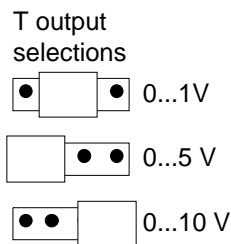
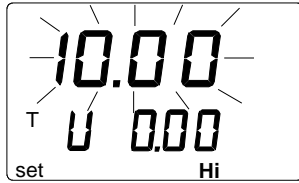

Figure 2.3.4 Jumper selections for the HMP140

You can now set the range with buttons ▲ or ▼ to correspond to the jumper position. Acknowledge the setting with ENTER. A text similar to the following is displayed:



Numbers on the second line are blinking. They indicate the lower limit of the transmitter's voltage range currently stored in the HMI41 memory. Text in the lower righthand corner is Lo. You can now set the lower limit with buttons ▲ or ▼ to correspond to that of the transmitter. Acknowledge the selection with ENTER. A text similar to the following is displayed:



Numbers on the first line start to blink. They indicate the upper limit of the transmitter's voltage range currently stored in the HMI41 memory. Text in the lower righthand corner is Hi. You can now set the upper limit with buttons ▲ or ▼ to correspond to that of the transmitter. Acknowledge the setting with ENTER. A text similar to the following is displayed:



Numbers on the second line are blinking. They indicate the lower limit of the transmitter's temperature range currently stored in the HMI41 memory. Text in the lower righthand corner is Lo. You can now set the lower limit to correspond to that of the transmitter. Set the limit with buttons ▲ or ▼ and acknowledge the setting with ENTER:

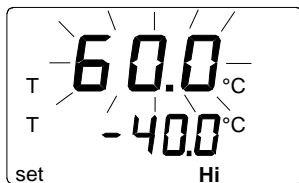

Numbers on the first line start to blink. They indicate the upper limit of the transmitter's temperature range currently stored in the HMI41 memory. Text in the lower righthand corner is Hi. You can now set the upper limit to correspond to that of the transmitter. Set the limit with buttons ▲ or ▼ and acknowledge the setting with ENTER. Turn the HMI41 off with the ON/OFF button. You can now calibrate the transmitter (see Chapter 3).

2.3.4 Customized current output selection mode (cI)

The customized current output selection mode (cI) is selected when the scaling of the RH, T and/or current range is not a standard one.

NOTE

When calibrating transmitters with current outputs, make sure that the output loop is terminated.



Select the cI selection mode with buttons ▲ or ▼ and acknowledge the selection with ENTER. A text similar to the following is displayed:



2.3.4.1 Humidity channel



Numbers on the second line are blinking. They indicate the current range of the transmitter's RH channel currently stored in the HMI41 memory. Select the range with buttons ▲ or ▼ to correspond to that of the transmitter. Acknowledge the selection with ENTER. A text similar to the following is displayed:

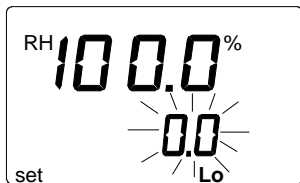

Numbers on the second line are blinking. They indicate the lower limit of the transmitter's RH range currently stored in the HMI41 memory. Text in the lower righthand corner is Lo. You can now set the lower limit to correspond to that of the transmitter. Set the limit with buttons ▲ or ▼ and acknowledge the setting with ENTER:

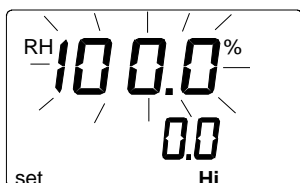

Numbers on the first line start to blink. They indicate the upper limit of the transmitter's RH range currently stored in the HMI41 memory. Text in the

lower righthand corner is Hi. You can now set the upper limit to correspond to that of the transmitter. Set the limit with buttons ▲ or ▼ and acknowledge the setting with ENTER. The HMI41 goes on to T channel settings and a text similar to the following is displayed:



2.3.4.2 Temperature channel

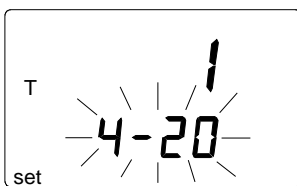

Numbers on the second line are blinking. They indicate the current range of the transmitter's T channel currently stored in the HMI41 memory. Select the range with buttons ▲ or ▼ to correspond to that of the transmitter. Acknowledge the selection with ENTER. A text similar to the following is displayed:



Numbers on the second line are blinking. They indicate the lower limit of the transmitter's temperature range currently stored in the HMI41 memory. Text in the lower righthand corner is Lo. You can now set the lower limit to correspond to that of the transmitter. Set the limit with buttons ▲ or ▼ and acknowledge the setting with ENTER:



Numbers on the first line start to blink. They indicate the upper limit of the transmitter's temperature range currently stored in the HMI41 memory. Text in the lower righthand corner is Hi. You can now set the upper limit to correspond to that of the transmitter. Set the limit with buttons ▲ or ▼ and acknowledge the setting with ENTER. Turn the HMI41 off with the ON/OFF button. You can now calibrate the transmitter (Chapter 3).

3. CALIBRATION

For a successful calibration, it is essential that the probe of the HMI41 and that of the transmitter are at the same temperature, and that the reference probe has been previously calibrated. Always allow enough time for the readings to stabilize. Note that the stabilization time depends on the ambient conditions and may vary from 10 minutes to a couple of hours.

3.1 Getting started

After having selected the desired function (Chapter 1.2) and necessary scale selections (Chapter 2), turn the HMI41 off and connect the calibration cable to the EXT connector at the bottom of the HMI41 (see Figure 3.1) and to the appropriate connector in the transmitter (see Figures 3.2 - 3.4).

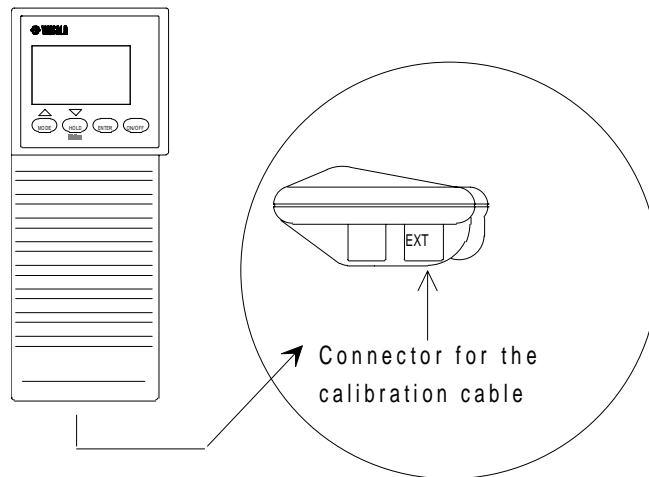

Figure 3.1 Location of the HMI41 calibration connector

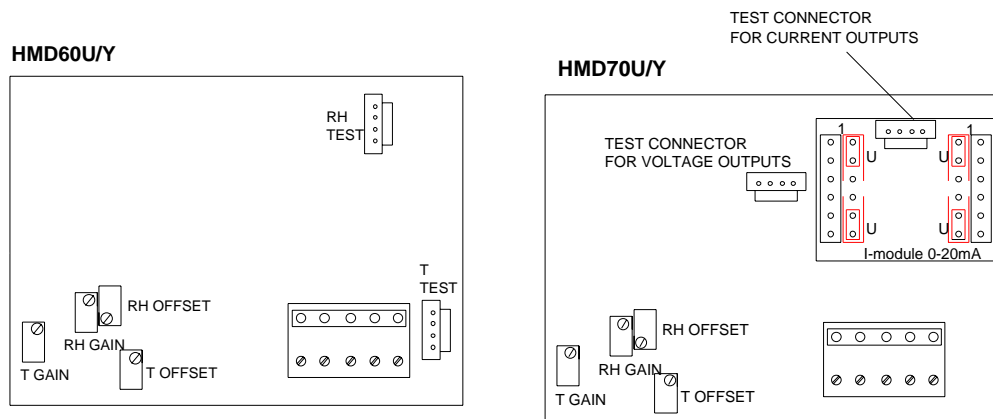

Figure 3.2 Calibration connectors and potentiometers in the HMD60 and HMD70 transmitters

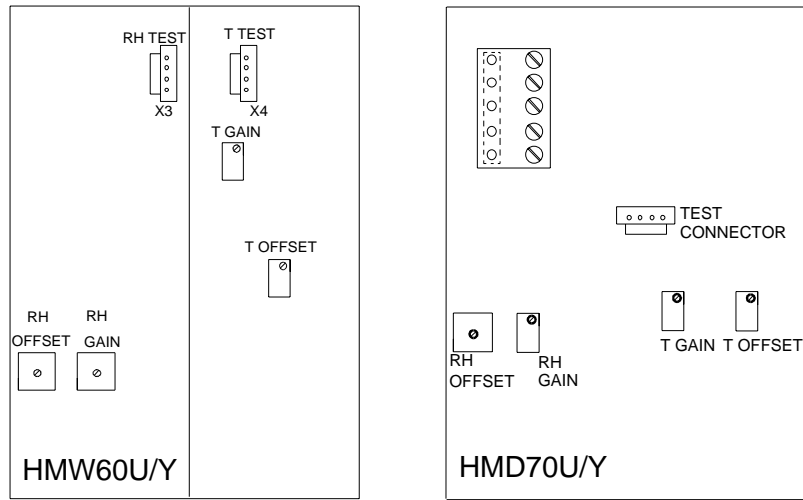

Figure 3.3 Calibration connectors and potentiometers in the HMW60 and HMW70 transmitters

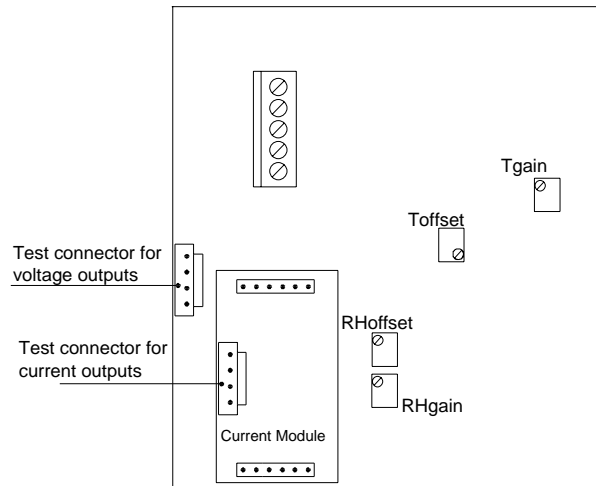

Figure 3.4 Calibration connectors and potentiometers in the HMP140 series transmitters

3.2 Humidity calibration

When performing the humidity calibration of the HMD/W60 transmitters, make sure that the calibration cable is connected to the RH test connector (Figures 3.2 and 3.3).

After having connected the cable, turn the HMI41 on with the ON/OFF button and wait until the following text appears on the display:



This message remains on the display for about 5 seconds. Press no button when this text is displayed and the HMI41 will automatically go on to calibration; a text similar to the following appears:

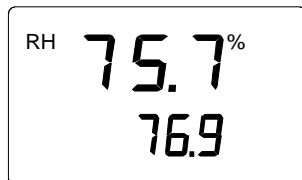

Numbers on the first line indicate the relative humidity measured by the transmitter, and numbers on the second line indicate the RH measured by the HMI41 reference probe. If you wish, you can now adjust the transmitter:

- Wait until the readings have stabilized and adjust the calibration potentiometers (Figures 3.2 - 3.4) until the readings on the first and the second line are the same. It is recommended to use the offset potentiometer if the RH is <65 %RH and the gain potentiometer if the RH is ≥ 65 %RH.
- After having completed the calibration, press MODE if you wish to perform a temperature calibration (see next page), or ON/OFF (disconnect the cable).

If you press the HOLD button in the first RH calibration mode, you will go on to the second RH calibration mode which is an alternative for the first one. A text similar to the following is displayed:

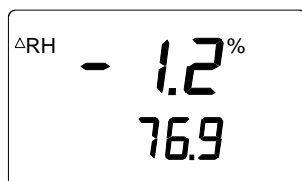

Numbers on the first line indicate how much the RH measured by the transmitter differs from that measured by the HMI41 reference probe. Numbers on the second line indicate the relative humidity measured by the reference probe. If you wish, you can now adjust the transmitter (by pressing HOLD again you will return to the previous RH calibration mode):

- Wait until the readings have stabilized and adjust the calibration potentiometers (Figures 3.2 - 3.4) until the numbers on the first line are at zero. It is recommended to use the offset potentiometer if the RH is <65 %RH and the gain potentiometer if the RH is ≥ 65 %RH.
- After having completed the calibration, press MODE if you wish to perform a temperature calibration (see below), or ON/OFF (disconnect the cable).

3.3 Temperature calibration

As the temperature sensor is extremely stable, temperature calibration should be used for check-ups only. Before starting the temperature calibration, leave the transmitter and the HMI41 to the same room at least for an hour so that their temperatures have enough time to equalize. If the difference between the readings is less than 0.5 °C, make no adjustments.

When performing the temperature calibration of the HMD/W60 transmitters, make sure that the calibration cable is connected to the T test connector (Figures 3.2 and 3.3).

Temperature calibration is entered through the RH calibration modes (see Chapter 3.2). By pressing MODE in the first RH calibration mode, a text similar to the following is displayed:



Numbers on the first line indicate the temperature measured by the transmitter, and numbers on the second line indicate the temperature measured by the HMI41. If you wish, you can now adjust the transmitter (by pressing the MODE button you will return to the RH calibration mode):

- Wait until the readings have stabilized and then adjust the calibration potentiometer (Figures 3.2 - 3.4) until the readings on the first and the second line are the same. It is recommended to use the offset potentiometer.
- After having completed the calibration, press ON/OFF and disconnect the cable.

If you press the HOLD button in the first T calibration mode, you will go on to the second T calibration mode which is an alternative for the first one. A text similar to the following is displayed:



Numbers on the first line indicate how much the temperature measured by the transmitter differs from that measured by the HMI41 reference probe. Numbers on the second line indicate the temperature measured by the reference probe. If you wish, you can now adjust the transmitter (by pressing the HOLD button again you will return to the previous T calibration mode and by pressing the MODE button you will return to the second RH calibration mode):

- Wait until the readings have stabilized and then adjust the calibration potentiometer (Figures 3.2 - 3.4) until the numbers on the first line are at zero. It is recommended to use the offset potentiometer.
- After having completed the calibration, press ON/OFF and disconnect the cable.

GUARANTEE



Vaisala issues a guarantee for the material and workmanship of this product under normal operating conditions for one (1) year from the date of delivery. Exceptional operating conditions, damage due to careless handling and mis-application will void the guarantee.

APPENDIX 1: QUICK REFERENCE TO SCALE SELECTIONS AND CALIBRATION

It is recommended that this quick reference guide is used only as a checking list for those who already know how to operate the HMI41 as a calibrator. For those who take it into use for the first time, the Operating Manual gives useful information that is not included in this quick reference guide.

1. Selecting the calibrator function

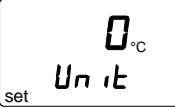
For selecting the calibrator function, press ON/OFF until you can see some text on the display. Then release the ON/OFF button and press within 1...2 seconds both ENTER and MODE buttons until the text "setup" appears on the display. Then follow the instructions of the table below.

DISPLAY	WHAT TO DO	PRESS:
	Wait for a few seconds.	
	If the basic settings have been given, press ENTER. If they have not been given, refer to the HMI41 Operating Manual.	press ENTER repeatedly:
	select the HMI41 function: 1 = indicator 2 = calibrator for HMD/W60/70 and HMP140 series analogue transmitters 3 = calibrator for HMP230 transmitters 4 = calibrator for HMD/W20/30 and HMP130 series transmitters	▲ (number up) or ▼ (number down) ON/OFF

2. Scale selection modes





The HMI41 automatically assumes the function selected in the setup menu when it is turned on again with the ON/OFF button. In the following, you will find a summary of the scale selection modes.

DISPLAY	DESCRIPTION
	The HMI41 has been turned on.
	Indication of the software version (if the version is 1.02 or more)
	Indication of the battery voltage.
	Press any button except ON/OFF within 5 seconds to enter the scale selection modes.
	Select the desired scale selection mode with buttons ▲ or ▼ and acknowledge the selection with ENTER. Then follow the instructions of tables 2.1 - 2.5 accordingly.

2.1 Voltage output scale selection mode (U)

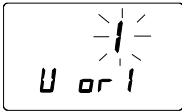
DISPLAY	WHAT TO DO	PRESS:
	Select the voltage output scale selection mode (U)	▲ (number up) or ▼ (number down) ENTER to acknowledge the selection
	Set the lower limit of the temperature range	▲ (number up) or ▼ (number down) ENTER to acknowledge the selection
	Set the upper limit of the temperature range	▲ (number up) or ▼ (number down) ENTER to acknowledge the selection ON/OFF

2.2 Current output scale selection mode (I)

DISPLAY	WHAT TO DO	PRESS:
	Select the current output scale selection mode (I)	▲ (number up) or ▼ (number down) ENTER to acknowledge the selection
	Select the output (0...20 mA or 4...20 mA)	▲ (number up) or ▼ (number down) ENTER to acknowledge the selection
	Set the lower limit of the temperature range	▲ (number up) or ▼ (number down) ENTER to acknowledge the selection
	Set the upper limit of the temperature range	▲ (number up) or ▼ (number down) ENTER to acknowledge the selection ON/OFF



2.3 Customized voltage output selection mode (cU)

DISPLAY	WHAT TO DO	PRESS:
	Select the customized voltage output scale selection mode (cU)	▲ (number up) or ▼ (number down) ENTER to acknowledge the selection
	Select the jumper selected RH channel's voltage output range (0...1V, 0...5V, 0...10V)	▲ (number up) or ▼ (number down) ENTER to acknowledge the selection
	Set the lower limit of the RH channel's voltage range	▲ (number up) or ▼ (number down) ENTER to acknowledge the selection
	Set the upper limit of the RH channel's voltage range	▲ (number up) or ▼ (number down) ENTER to acknowledge the selection
	Set the lower limit of the humidity range	▲ (number up) or ▼ (number down) ENTER to acknowledge the selection
	Set the upper limit of the humidity range	▲ (number up) or ▼ (number down) ENTER to acknowledge the selection
	Select the jumper selected T channel's voltage output range (0...1V, 0...5V, 0...10V)	▲ (number up) or ▼ (number down) ENTER to acknowledge the selection
	Set the lower limit of the T channel's voltage range	▲ (number up) or ▼ (number down) ENTER to acknowledge the selection
	Set the upper limit of the T channel's voltage range	▲ (number up) or ▼ (number down) ENTER to acknowledge the selection
	Set the lower limit of the temperature range	▲ (number up) or ▼ (number down) ENTER to acknowledge the selection
	Set the upper limit of the temperature range	▲ (number up) or ▼ (number down) ENTER to acknowledge the selection press ON/OFF

2.4 Customized current output selection mode (cI)

DISPLAY	WHAT TO DO	PRESS:
	Select the customized current output scale selection mode (cI)	▲ (number up) or ▼ (number down) ENTER to acknowledge the selection
	Select the RH channel's current output range (4...20 mA, 0...20 mA)	▲ (number up) or ▼ (number down) ENTER to acknowledge the selection
	Set the lower limit of the humidity range	▲ (number up) or ▼ (number down) ENTER to acknowledge the selection
	Set the upper limit of the humidity range	▲ (number up) or ▼ (number down) ENTER to acknowledge the selection
	Select the T channel's current output range (4...20 mA, 0...20 mA)	▲ (number up) or ▼ (number down) ENTER to acknowledge the selection
	Set the lower limit of the temperature range	▲ (number up) or ▼ (number down) ENTER to acknowledge the selection
	Set the upper limit of the temperature range	▲ (number up) or ▼ (number down) ENTER to acknowledge the selection press ON/OFF

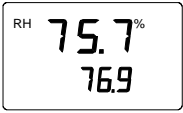
2.5 Calibration

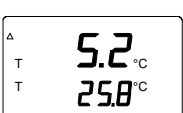
DISPLAY	WHAT TO DO	PRESS:
	Wait for about 5 seconds.	
	Let the readings stabilize and then adjust the transmitter potentiometers until the readings are the same. Alternatively, you can calibrate the transmitter in the second RH calibration mode (see below).	HOLD to enter the second RH calibration mode MODE to enter the first T calibration mode ON/OFF if you have completed the calibration
	Let the readings stabilize and then adjust the transmitter potentiometers until the reading on the first line is at zero	HOLD to return to the first RH calibration mode MODE to enter the second T calibration mode ON/OFF if you have completed the calibration
	Let the readings stabilize and then adjust the transmitter offset potentiometer until the readings are the same. Alternatively, you can calibrate the transmitter in the second T calibration mode (see below).	HOLD to enter the second T calibration mode MODE to return to the first RH calibration mode ON/OFF if you have completed the calibration
	Let the readings stabilize and then adjust the transmitter offset potentiometer until the reading on the first line is at zero.	HOLD to return to the first T calibration mode MODE to return to the second RH calibration mode ON/OFF if you have completed the calibration

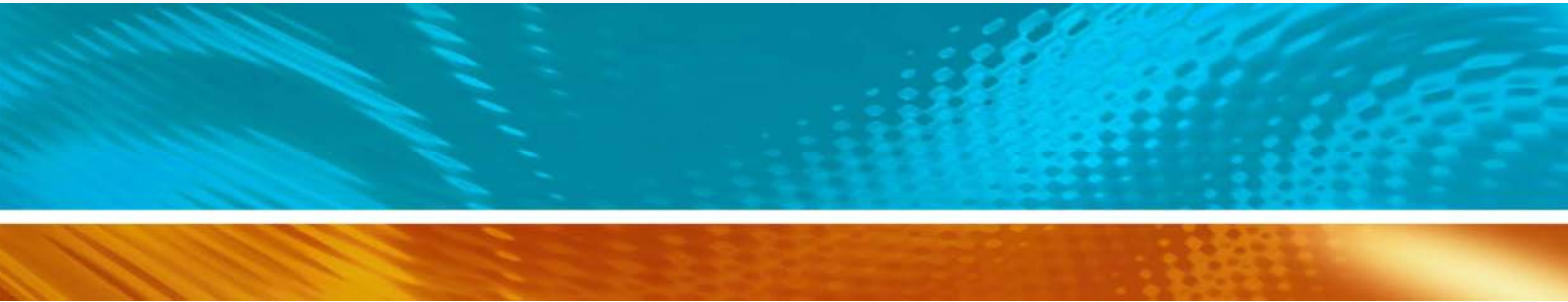

www.vaisala.com

